

Accessories Program

Contents	
1	Hydraulic connections..... 2
1.1	Filter (separately)..... 2
1.2	Filter set..... 3
1.3	Filter set (adjustable)..... 3
1.4	Connection set main/return line..... 4
1.5	Connection set mould..... 4
1.6	Hose PTFE..... 5
1.7	Hose PFA..... 6
1.8	Hose WFI..... 7
1.9	Hose stainless..... 8
1.10	Hose NBR..... 9
1.11	Connection set cooling-, separate system water..... 10
1.12	Nipple..... 10
1.13	Adjustable screw joint..... 11
1.14	Adapter for central coupling cooling water..... 12
1.15	Adapter for central coupling main/return line..... 12
1.16	Adapter for central coupling main/return line (with main line filter)..... 13
1.17	Manifold with/without shut-off valves..... 14
1.18	Connection set Vario-5/Thermo-5..... 15
1.19	Connection set Vario-5/Mould..... 17
1.20	Connection set Treat-5 to Thermo-5 or Thermo-6..... 18
2	Electrical connections..... 20
2.1	Cable interface OPC UA (ZO)..... 20
2.2	Cable interface DIGITAL (ZD)..... 20
2.3	Cable interface CAN (ZC)..... 23
2.4	Cable interface HB (internal interface)..... 24
2.5	Cable interface HB/CAN (internal interface)..... 25
2.6	Various cables..... 26
2.7	Heat sensor..... 26
2.8	Mains connector..... 27
2.9	Connector (other)..... 28
2.10	Power distributor..... 28
3	Miscellaneous accessories..... 29
3.1	Screen protector Thermo-6..... 29
3.2	Interface server Gate-6..... 29
3.3	Checking facility for temperature control units..... 30
3.4	Keyboard-protection (Thermo-5, Treat-5, Clean-5, Panel-5)..... 30
3.5	Flow meter Flow-5, unit attachment..... 31
3.6	Flow meter Flow-5, autonomic assembly..... 32
3.7	Control module Panel-5..... 33
3.8	Carrier frame with central water supply..... 34
3.9	Switching unit Vario-5..... 36
3.10	Water treatment unit Treat-5..... 37
3.11	Cleaning unit Clean-5..... 37
3.12	Shipping crate (wood)..... 38
4	Manual..... 39
4.1	Units (Operating manuals, process descriptions, instruction manuals)..... 39
4.2	Other..... 40

1 Hydraulic connections

Notes: The cross-sections of hydraulic connections are based on the expected flow rate. Cross-sectional constrictions lead to pressure loss and reduce the flow rate.

Insulated hoses can reduce radiation losses and also protect against burns.

Following ISO 7/228, the designation **G** is used for connections where the pipe threads are not water-tight (with sealing lip), and the designation **R** for thread sealing connections (conical external thread).

The temperature data for the hydraulic connections refer to the maximum main line temperatures of the unit for simplifying an evaluation. The temperature stabilities of the components are usually higher than the values quoted.

For main line temperatures for water 180 °C and for oil 200 °C liquid sealing H1020 must be used instead of H1015.

1.1 Filter (separately)

brass (thread sealing) water up to 160 °C, oil up to 200 °C

	Filter brass (filter stainless 0,5 mm)								
---	--	--	--	--	--	--	--	--	--

G^{3/4}	O/ID	T24133							
G1 1/4	O/ID	T24135							

Ordering example: Filter brass, G^{3/4} (O/ID T24133)

stainless (thread sealing) water up to 180 °C

	Filter stainless (filter stainless 0,5 mm)								
---	--	--	--	--	--	--	--	--	--

G1 1/4	O/ID	T25745							
---------------	------	--------	--	--	--	--	--	--	--

Ordering example: Filter stainless, G1 1/4 (O/ID T25745)

stainless (for sealing lip) water up to 180 °C, oil up to 250 °C

	Filter stainless (filter stainless 0,5 mm)								
---	--	--	--	--	--	--	--	--	--

G^{3/4}	O/ID	T25531							
------------------------	------	--------	--	--	--	--	--	--	--

Ordering example: Filter stainless, G^{3/4} (O/ID T25531)

1.2 Filter set									
brass (thread sealing)		water up to 160 °C, oil up to 200 °C							
	1x Filter brass (filter stainless 0,5 mm) 1x Nipple (thread sealing; T24141: brass; T24142: stainless)								
	R ^{3/4}	O/ID	T24141						
R1 1/4	O/ID	T24142							

Ordering example: Filter set brass, R^{3/4} (O/ID T24141)

stainless (thread sealing)		water up to 180 °C							
	1x Filter stainless (filter stainless 0,5 mm) 1x Nipple (thread sealing; T25661: brass; T25750: stainless)								
	R ^{3/4}	O/ID	T25661						
R1 1/4	O/ID	T25750							

Ordering example: Filter set stainless, R^{3/4} (O/ID T25661)

1.3 Filter set (adjustable)									
brass (thread sealing)		water up to 160 °C, oil up to 200 °C							
	1x Filter brass (filter stainless 0,5 mm) 1x Adjustable screw joint brass (thread sealing)								
	R ^{3/4}	O/ID	T24720						

Ordering example: Filter set (adjustable) brass, R^{3/4} (O/ID T24720)

stainless (thread sealing)		water up to 180 °C							
	1x Filter stainless (filter stainless 0,5 mm) 1x Adjustable screw joint brass (thread sealing)								
	R ^{3/4}	O/ID	T25774						

Ordering example: Filter set (adjustable) stainless, R^{3/4} (O/ID T25774)

stainless (for sealing lip)		water up to 180 °C, oil up to 250 °C							
	1x Filter stainless (filter stainless 0,5 mm) 1x Adjustable screw joint stainless (for sealing lip)								
	G ^{3/4}	O/ID	T24143						

Ordering example: Filter set (adjustable) stainless, G^{3/4} (O/ID T24143)

1.4 Connection set main/return line

stainless (thread sealing)		water up to 180 °C, oil up to 200 °C							
	2x	Nipple stainless (screw-in side thread sealing; hose side 24° conical nipple with metric thread)							
		M14x1,5	M16x1,5	M18x1,5	M22x1,5	M26x1,5	M30x2	M36x2	M45x2
R$\frac{1}{2}$	O/ID	T28194-1	T28194-2						
R$\frac{3}{4}$	O/ID	T24146-1	T24146-2	T24146-3	T24146-4	T24146-5	T24146-6		
R1 $\frac{1}{4}$	O/ID							T24147-7	T24147-8

Ordering example: Connection set main/return line stainless, R $\frac{3}{4}$ - M22x1,5 (O/ID T24146-4)

stainless (for sealing lip)		water up to 230 °C, oil up to 250 °C							
	2x	Nipple stainless (screw-in side with sealing lip; hose side 24° conical nipple with metric thread)							
		M14x1,5	M16x1,5	M18x1,5	M22x1,5	M26x1,5	M30x2		
G$\frac{3}{4}$	O/ID	T22275-1	T22275-2	T22275-3	T22275-4	T22275-5	T22275-6		

Ordering example: Connection set main/return line stainless, G $\frac{3}{4}$ - M22x1,5 (O/ID T22275-4)

stainless (for sealing lip), NPT (USA)		water up to 230 °C, oil up to 250 °C							
	2x	Nipple stainless (screw-in side with sealing lip; hose side with NPT thread (National Pipe Tapered))							
		R1 $\frac{1}{4}$							
G1 $\frac{1}{4}$	O/ID	T28794-5							

Ordering example: Connection set main/return line stainless, G1 $\frac{1}{4}$ - R1 $\frac{1}{4}$ (O/ID T28754-5)

1.5 Connection set mould

stainless (for sealing lip)		water up to 230 °C							
	2x	Nipple stainless (screw-in side with sealing lip; hose side 24° conical nipple with metric thread)							
		M18x1,5	M22x1,5						
G$\frac{3}{8}$	O/ID	T28150-3	T28150-4						
G$\frac{1}{2}$	O/ID		T28151-4						

Ordering example: Connection set mould stainless, G $\frac{1}{2}$ - M22x1,5 (O/ID T28151-4)

1.6 Hose PTFE

non-insulated water up to 180 °C, oil up to 200 °C



Hose PTFE (smooth hose with metal cladding and universal conical seal stainless; nut and press mounting made of steel, thick-layer passivated and sealed; max. operating pressure 25 bar)

		DN10		DN13		DN16	DN25	
		M14x1,5	M18x1,5	M16x1,5	M22x1,5	M26x1,5	M36x2	
Length mm	500	O/ID	T21783-3					
	750	O/ID	T21783-4			T21786-4		
	800	O/ID			T21785-28			
	1000	O/ID	T21783-5		T21785-5	T21786-5		
	1200	O/ID					T21788-32	
	1500	O/ID	T21783-6	T21784-6	T21785-6	T21786-6	T21788-6	
	1600	O/ID					T21788-35	
	1800	O/ID			T21785-37			
	2000	O/ID	T21783-7	T21784-7	T21785-7	T21786-7	T21788-7	
	2500	O/ID	T21783-8	T21784-8	T21785-8	T21786-8	T21788-8	
	3000	O/ID	T21783-9	T21784-9	T21785-9	T21786-9	T21788-9	T26297-9
	3500	O/ID			T21785-12			
	4000	O/ID			T21785-10	T21786-10	T21788-10	T26297-10
	5000	O/ID			T21785-13		T21788-11	T26297-11
	6000	O/ID			T21785-14			
Bend radius mm			>100	>100	>135	>135	>160	>250

Ordering example: Hose PTFE, M22x1,5; DN13x3000 (O/ID 21786-9)

insulated water up to 180 °C, oil up to 200 °C



Hose PTFE insulated (smooth hose with metal cladding and universal conical seal stainless; nut and press mounting made of steel, thick-layer passivated and sealed; max. operating pressure 25 bar)

		DN10		DN13		DN16		
		M14x1,5		M16x1,5	M22x1,5	M26x1,5		
Length mm	1000	O/ID			T21785-501			
	1500	O/ID				T21786-601		
	2000	O/ID	T21783-701		T21785-701	T21786-701		
	2500	O/ID			T21785-801			
	3000	O/ID			T21785-901	T21786-901	T21788-901	
	3500	O/ID			T21785-121			
	4000	O/ID			T21785-101			
	4500	O/ID			T21785-151			
	5000	O/ID	T21783-111					
	6000	O/ID			T21785-141			
Bend radius mm			>100	>135	>135	>160		

Ordering example: Hose PTFE insulated, M22x1,5; DN13x3000 (O/ID T21786-901)

1.7 Hose PFA

non-insulated water up to 180 °C, oil up to 200 °C

			Hose PFA (highly flexible corrugated hose with metal cladding and universal conical seal stainless; nut and press mounting made of steel, thick-layer passivated and sealed; max. operating pressure 25 bar)								
			DN8		DN10		DN13		DN16	DN25	
			M14x1,5	M14x1,5	G¾	M16x1,5	G¾	M26x1,5	M36x2		
Length mm	250	O/ID	T21791-1	T21792-1	T22609-1	T21793-1	T22610-1				
	350	O/ID	T21791-2	T21792-2	T22609-2	T21793-2	T22610-2	T21794-2			
	500	O/ID	T21791-3	T21792-3	T22609-3	T21793-3	T22610-3	T21794-3			
	750	O/ID	T21791-4	T21792-4	T22609-4	T21793-4	T22610-4	T21794-4			
	1000	O/ID	T21791-5	T21792-5	T22609-5	T21793-5	T22610-5	T21794-5	T26296-11		
	1200	O/ID		T21792-32							
	1500	O/ID				T21793-6	T22610-6				
	2000	O/ID		T21792-7		T21793-7		T21794-6	T26296-8		
	2500	O/ID		T21792-8		T21793-8	T22610-8				
	3000	O/ID		T21792-9		T21793-9					
	3500	O/ID				T21793-12					
	4000	O/ID		T21792-10		T21793-10			T26296-10		
	5000	O/ID		T21792-11		T21793-11					
	Bend radius mm			>40	>50	>50	>60	>60	>60	>80	

Ordering example: Hose PFA, M16x1,5; DN13x1000 (O/ID T21793-5)

insulated water up to 180 °C, oil up to 200 °C

			Hose PFA insulated (highly flexible corrugated hose with metal cladding and universal conical seal stainless; nut and press mounting made of steel, thick-layer passivated and sealed; max. operating pressure 25 bar)								
							DN13		DN16	DN25	
							M16x1,5		M26x1,5	M36x2	
Length mm	1000	O/ID				T21793-501		21794-501	T26296-111		
	2000	O/ID						21794-601	T26296-811		
	3000	O/ID				T21793-901		21794-901			
	3500	O/ID							T26296-911		
	4000	O/ID				T21793-101		21794-221			
	10000	O/ID									
Bend radius mm						>60		>60	>80		

Ordering example: Hose PFA insulated, M16x1,5; DN13x1000 (O/ID T21793-501)

1.8 Hose WFI

integrated insulation water up to 180 °C, oil up to 200 °C

		PFA corrugated hose with integrated insulation (parallel corrugation with triple insulation and universal INOX sealing cone; operating pressure 25 bar)						
		DN10		DN13		DN16	DN25	
		M14x1,5	G^{3/8}	M16x1,5	G^{3/8}	M26x1,5	M36x2	
Length mm	250	O/ID						
	350	O/ID				T29503-2		
	500	O/ID			T29501-3			
	1000	O/ID	T29500-1	T29501-4	T29502-4	T29503-4	T29505-4	
	2000	O/ID				T29504-5		
	3000	O/ID	T29500-6					
	4000	O/ID	T29500-7		T29502-7		T29505-7	
	5000	O/ID	T29500-8		T29502-8			
Bend radius mm			>60	>60	>75	>75	>85	>105

Ordering example: Hose WFI, M16x1,5; DN13x1000 (O/ID T29502-4)

Note: *The WFI hoses are not stock items. Prices vary significantly depending on the quantity and must therefore be requested from us individually.*



1.9 Hose stainless

non-insulated water up to 180 °C, oil up to 250 °C

			Hose stainless (highly flexible corrugated metal hose with metal cladding; welded universal conical seal stainless; nut and press mounting made of steel, thick-layer passivated and sealed; max. operating pressure 25 bar)						
			DN12	DN16	DN20				
			M22x1,5	M26x1,5	M30x2				
Length mm	750	O/ID	T21797-4						
	1000	O/ID	T21797-5	T21798-5					
	1500	O/ID	T21797-6	T21798-6	T21799-6				
	2000	O/ID	T21797-7	T21798-7	T21799-7				
	2500	O/ID	T21797-8	T21798-8	T21799-8				
	3000	O/ID	T21797-9	T21798-9	T21799-9				
	4000	O/ID	T21797-10	T21798-10	T21799-10				
	5000	O/ID	T21797-11	T21798-12					
Bend radius mm			>100	>110	>130				

Ordering example: *Hose stainless, M26x1,5; DN16x3000 (O/ID T21798-9)*

insulated water up to 180 °C, oil up to 250 °C

	Insulation – Variant 1:		Hose stainless insulated (highly flexible corrugated metal hose with metal cladding; welded universal conical seal stainless; nut and press mounting made of steel, thick-layer passivated and sealed; max. operating pressure 25 bar)					
			Insulation Variant 1: covered with a double-layered iso-THERM tube					
	Insulation – Variant 2:		Variant 2: covered with approximately 6 mm thick insulation tube					
			DN12	DN16	DN20			
			M22x1,5	M26x1,5	M30x2			
			Variant 1	Variant 2	Variant 2			
Length mm	750	O/ID	T21797-411					
	2000	O/ID	T21797-711					
	2500	O/ID		T21798-81	T21799-81			
	3000	O/ID		T21798-91				
	5000	O/ID	T21797-111					
	6000	O/ID		T21798-111				
Bend radius mm			>100	>110	>130			

Ordering example: *Hose stainless, M26x1,5; DN16x3000 (O/ID T21798-91)*

insulated water up to 230 °C

	Hose stainless insulated (flexible corrugated metal hose – hydraulically formed – with abrasion protection and metal cladding; welded universal conical seal and nut stainless; nut and press mounting made of steel, thick-layer passivated and sealed; Insulation: with fire protection hose; max. operating pressure 47 bar)							
	Note: The metal corrugated hose is a wear part at high temperatures. Weak point is the longitudinal weld seam. When bending, it should be inside of radius. For longer lifetime only use hydraulically formed corrugated hoses (no mechanically formed!)							
			DN10	DN12				
			M18x1,5	M22x1,5				
	Length mm	750	u/ID	T28013-6	T27895-4			
	2000	u/ID	T28013-7					
	3400	u/ID	T28013-3					
	4000	u/ID		T27895-10				
Bend radius mm			>150	>165				

Ordering example: Hose stainless insulated, M22x1,5; DN12x4000 (O/ID T27895-10)

Note: The insulated stainless hose for water up to 230 °C are not stock items. Prices vary significantly depending on the quantity and must therefore be requested from us individually.

1.10 Hose NBR

(only suitable for cooling and system water) water up to 100 °C

	High flexible universal pressure hose; max. operating pressure 10 bar						
			DN9	DN13	DN19		
Length X in m	O/ID	T22273-1	T22273-2	T22273-4			
Bend radius mm		>30	>50	>90			

Ordering example: Hose NBR DN13, Length X m (O/ID T22273-2)

1.11 Connection set cooling-, separate system water

Quick-release shut-off coupling, brass water up to 100 °C

	2x Nipple brass (thread sealing) 2x Quick-release shut-off coupling with valve and hose nozzles brass / Viton® (DuPont Dow Elastomers) 4x Hose clips 2x Cable straps (colour coding for cooling water)							
			DN9	DN13	DN19			
R¹/₄	O/ID	T24221						
R³/₈	O/ID	T22402	T22049					
R¹/₂	O/ID			T24215				
R³/₄	O/ID			T24222				

Ordering example: Connection set cooling-, separate system water, Quick-release shut-off coupling, brass R³/₈ - DN13 (O/ID T22049)

sealing cone, brass water up to 100 °C

	2x Nipple brass (male side thread sealing; female side with 60° sealing cone and inch thread) 2x Hose nozzles brass with swivel nuts steel zinc-plated (inch thread, universal sealing cone) 4x Hose clips 2x Cable straps (colour coding for cooling water)							
			DN9	DN13	DN19			
R¹/₄	O/ID	T23980						
R³/₈	O/ID	T22034	T23973					
R¹/₂	O/ID		T22050					
R³/₄	O/ID			T24216				

Ordering example: Connection set cooling-, separate system water, sealing cone, brass R³/₈ - DN13 (O/ID T23973)

1.12 Nipple

stainless (for sealing lip) water up to 230 °C, oil up to 200 °C

	Nipple stainless (external thread cylindrical with sealing lip)							
			DN9	DN13	DN19			
G¹/₂-¹/₄	O/ID	T21818-1						
G¹/₂-³/₈	O/ID	T21818-2						
G³/₄-¹/₄	O/ID	T21818-3						
G³/₄-³/₈	O/ID	T21818-4						
G¹-³/₄	O/ID	T21818-5						

Ordering example: Nipple stainless G³/₄ - ³/₈ (O/ID T21818-4)

brass (thread sealing) water up to 180 °C, oil up to 200 °C

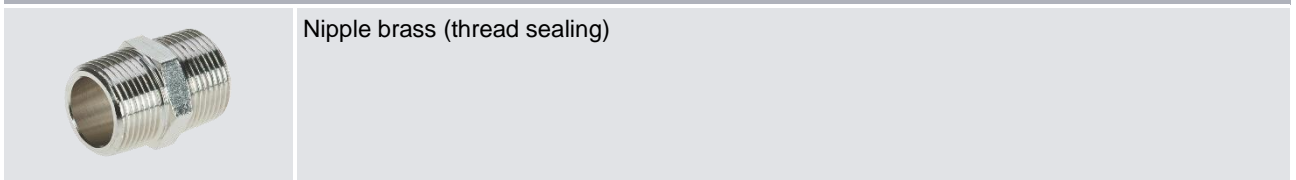

R^{3/4}	O/ID	T21763						
------------------------	------	--------	--	--	--	--	--	--

Ordering example: *Nipple brass, R^{3/4} (O/ID T21763)*

stainless (thread sealing) water up to 180 °C, oil up to 200 °C

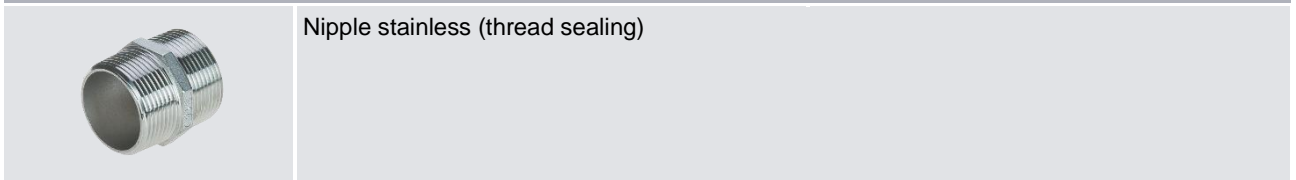

R1 1/4	O/ID	T25748						
---------------	------	--------	--	--	--	--	--	--

Ordering example: *Nipple stainless, R1 1/4 (O/ID T25748)*

1.13 Adjustable screw joint

brass (thread sealing) water up to 180 °C, oil up to 200 °C

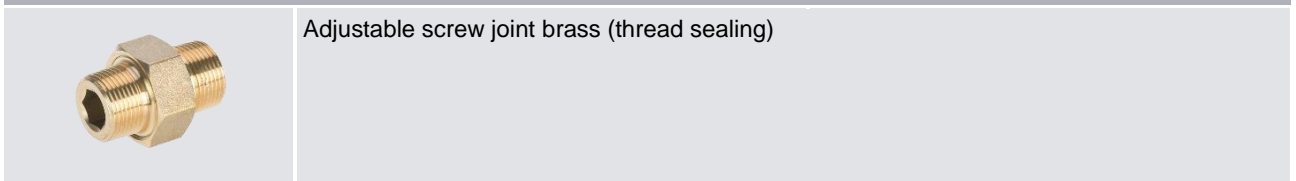

R^{1/2}	O/ID	T23087						
R^{3/4}	O/ID	T21163						

Ordering example: *Adjustable screw joint brass, R^{3/4} (O/ID T21163)*

stainless (with sealing lip) oil up to 250 °C

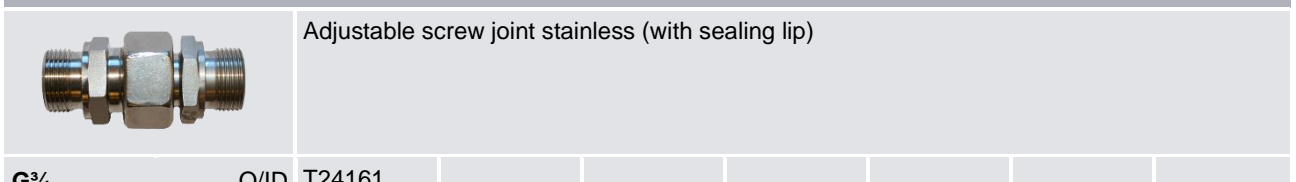

G^{3/4}	O/ID	T24161						
------------------------	------	--------	--	--	--	--	--	--

Ordering example: *Adjustable screw joint stainless, G^{3/4} (O/ID T24161)*

1.14 Adapter for central coupling cooling water

brass water up to 100 °C

	2x O-ring FPM 1x Cylinder head screw stainless M8x25 (Torque for cylinder head screw: 20 Nm)
---	---

Suitable for: - Thermo-6 (Housing size 61/62, with cooling A2/B2)	O/ID	T28810					
--	------	--------	--	--	--	--	--

Ordering example: Adapter for central coupling cooling water, brass (O/ID T28810)

brass water up to 100 °C

	2x O-ring FPM 1x Cylinder head screw stainless M8x40 (Torque for cylinder head screw: 20 Nm) 1x Spring washer 1x Locking ring
---	--

Suitable for: - Thermo-5 (housing size 1/2) - Treat-5 (housing size 2)	O/ID	T28008					
--	------	--------	--	--	--	--	--

Ordering example: Adapter for central coupling cooling water, brass (O/ID T28008)

1.15 Adapter for central coupling main/return line

brass water up to 160 °C, oil up to 200 °C

	2x O-ring FPM 1x Cylinder head screw stainless M8x40 (Torque for cylinder head screw: 20 Nm) 1x Spring washer 1x Locking ring
---	--

Suitable for: - Thermo-6 (housing size 61/62, with pump 4T/4S) - Thermo-5 (housing size 1/2) - Treat-5 (housing size 2)	O/ID	T25651					
--	------	--------	--	--	--	--	--

Ordering example: Adapter for central coupling main/return line, brass, water up to 160 °C (O/ID T25651)

brass water up to 180 °C

	2x O-ring FFKM 1x Cylinder head screw stainless M8x40 (Torque for cylinder head screw: 20 Nm) 1x Spring washer 1x Locking ring
---	---

Suitable for: - Thermo-5 (housing size 2)	O/ID	T25651-1					
--	------	----------	--	--	--	--	--

Ordering example: Adapter for central coupling main/return line, brass, water up to 180 °C (O/ID T25651-1)

1.16 Adapter for central coupling main/return line (with main line filter)

brass, with main line filter

water up to 160 °C, oil up to 200 °C



- 1x Filter brass
- 1x Nipple
- 2x O-ring FPM
- 1x Cylinder head screw stainless M8x40 (Torque for cylinder head screw: 20 Nm)
- 1x Spring washer
- 1x Locking ring

Suitable for:

O/ID

T25651-2

- Thermo-6 (housing size 61/62, with pump 4T/4S)
- Thermo-5 (housing size 1/2)
- Treat-5 (housing size 2)

Ordering example: Adapter for central coupling main/return line, brass, with main line filter, water up to 160 °C (O/ID T25651-2)

brass, with main line filter

water up to 180 °C



- 1x Filter stainless
- 1x Nipple
- 2x O-ring FFKM
- 1x Cylinder head screw stainless M8x40 (Torque for cylinder head screw: 20 Nm)
- 1x Spring washer
- 1x Locking ring

Suitable for:

O/ID

T25651-3

- Thermo-5 (housing size 2)

Ordering example: Adapter for central coupling main/return line, brass, with main line filter, water up to 180 °C (O/ID T25651-3)

1.17 Manifold with/without shut-off valves



O/ID: T24963



O/ID: T24963-6

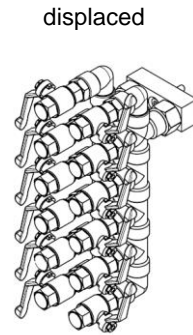

O/ID: T26804-4

with main line filter



O/ID: T26368-1

Model: Attachment

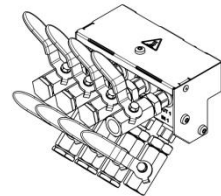

O/ID: T27999-3

Note: Torque for cylinder head screw M8: 20 Nm

Suitable for:	Water up to	Type of manifold	Note	O/ID
Thermo-6 - housing size 61 - housing size 62 with pump 4T/4S	160 °C	2x2xG½ with shut-off valves		T24963-5
		2x2xG½ with shut-off valves	with main line filter	T26368-3
		2x2xG¼ without shut-off valves	with main line filter	T26368-1
		2x3xG½ with shut-off valves		T26068
		2x4xG½ with shut-off valves		T24963
		2x4xG½ with shut-off valves	with main line filter	T26368-4
		2x4xG½ without shut-off valves		T24963-1
		2x4xG¾ without shut-off valves	with main line filter	T26368-2
		2x5xG½ with shut-off valves	displaced	T26804-2
		2x6xG½ with shut-off valves	displaced	T26804-1
Thermo-5 - housing size 2	180 °C	2x2xG½ with shut-off valves	model: attachment	T27999-1
		2x3xG½ with shut-off valves	model: attachment	T27999-2
		2x4xG½ with shut-off valves	model: attachment	T27999-3
		2x4xG½ without shut-off valves	model: attachment	T27610
		2x4xG½ with shut-off valves		T24963-6
		2x4xG½ without shut-off valves		T24963-2
		2x5xG½ with shut-off valves	displaced	T26804-3
		2x6xG½ with shut-off valves		T24963-8
		2x6xG½ without shut-off valves		T24963-3
		2x6xG⅝ with shut-off valves		T24963-4
		2x6xG⅝ with shut-off valves	displaced	T26804-4
Thermo-5 - housing size 2B	230 °C	2x4xG½ without shut-off valves		T28014

Ordering example: Manifold 2x4xG½ with shut-off valves (attachment), water up to 180 °C (O/ID T27999-3)

Suitable for	Oil up to	Type of manifold	Note	O/ID
Thermo-5 - housing size 2	200 °C	2x2xG½ with shut-off valves		T24963-9
		2x4xG½ with shut-off valves		T24963-7
Thermo-5 - housing size 3	250 °C	2x2xG¾ without shut-off valves		T27858

1.18 Connection set Vario-5/Thermo-5



non-insulated – suitable for housing size 1 or 2 water up to 180 °C

	2x	Hose PTFE M22x1,5, DN13 (smooth hose with metal cladding and universal conical seal stainless; nut and press mounting made of steel, thick-layer passivated and sealed; max. operating pressure 25 bar)
	4x	Nipple stainless G¾-M22x1,5 (screw-in side with sealing lip; hose side 24° conical nipple with metric thread)

Length mm	3000	O/ID	T26847-9						
Bend radius mm	>135								

Ordering example: Connection set Vario-5/Thermo-5 , Length 3000 mm (O/ID T26847-9)

insulated – suitable for housing size 1 or 2 water up to 180 °C

	2x	Hose PTFE insulated M22x1,5, DN13 (smooth hose with metal cladding and universal conical seal stainless; nut and press mounting made of steel, thick-layer passivated and sealed; max. operating pressure 25 bar)
	4x	Nipple stainless G¾-M22x1,5 (screw-in side with sealing lip; hose side 24° conical nipple with metric thread)

Length mm	3000	O/ID	T26847-901						
Bend radius mm	>135								

Ordering example: Connection set Vario-5/Thermo-5 insulated, Length 3000 mm (O/ID T26847-901)

non-insulated – suitable for housing size 3 water up to 180 °C

	2x	Hose PTFE M22x1,5, DN13 (smooth hose with metal cladding and universal conical seal stainless; nut and press mounting made of steel, thick-layer passivated and sealed; max. operating pressure 25 bar)						
	2x	Nipple stainless R1 ¼ -M22x1,5 (screw-in side thread sealing; hose side 24° conical nipple with metric thread)						
	2x	Nipple stainless G¾-M22x1,5 (screw-in side with sealing lip; hose side 24° conical nipple with metric thread)						
Length mm	3000	O/ID	T26848-9					
Bend radius mm	>135							

Ordering example: Connection set Vario-5/Thermo-5, Length 3000 mm (O/ID T26848-9)

insulated – suitable for housing size 3 water up to 180 °C

	2x	Hose PTFE insulated M22x1,5, DN13 (smooth hose with metal cladding and universal conical seal stainless; nut and press mounting made of steel, thick-layer passivated and sealed; max. operating pressure 25 bar)						
	2x	Nipple stainless R1 ¼ -M22x1,5 (screw-in side thread sealing; hose side 24° conical nipple with metric thread)						
	2x	Nipple stainless G¾-M22x1,5 (screw-in side with sealing lip; hose side 24° conical nipple with metric thread)						
Length mm	2000	O/ID	T26848-801					
	3000	O/ID	T26848-901					
Bend radius mm	>135							

Ordering example: Connection set Vario-5/Thermo-5 insulated, Length 3000 mm (O/ID T26848-901)

1.19 Connection set Vario-5/Mould

non-insulated

water up to 180 °C

	2x	Hose PTFE insulated M22x1,5, DN13 (smooth hose with metal cladding and universal conical seal stainless; nut and press mounting made of steel, thick-layer passivated and sealed; max. operating pressure 25 bar)						
	2x	Nipple stainless G $\frac{3}{4}$ -M22x1,5 (screw-in side with sealing lip; hose side 24° conical nipple with metric thread)						
	2x	Nipple stainless G $\frac{1}{2}$ -M22x1,5 (screw-in side with sealing lip; hose side 24° conical nipple with metric thread)						
Length mm	1500	O/ID	T26841-6					
	2000	O/ID	T26841-7					
Bend radius mm	>135							

Ordering example: Connection set Vario-5/Mould, Length 2000 mm (O/ID T26841-7)

insulated

water up to 180 °C

	2x	Hose PTFE M22x1,5, DN13 (smooth hose with metal cladding and universal conical seal stainless; nut and press mounting made of steel, thick-layer passivated and sealed; max. operating pressure 25 bar)						
	2x	Nipple stainless G $\frac{3}{4}$ -M22x1,5 (screw-in side with sealing lip; hose side 24° conical nipple with metric thread)						
	2x	Nipple stainless G $\frac{1}{2}$ -M22x1,5 (screw-in side with sealing lip; hose side 24° conical nipple with metric thread)						
Length mm	1500	O/ID	T26841-601					
	2000	O/ID	T26841-701					
Bend radius mm	>135							

Ordering example: Connection set Vario-5/Mould insulated, Length 2000 mm (O/ID T26841-701)

1.20 Connection set Treat-5 to Thermo-5 or Thermo-6



Connection set Treat-5 to 1xThermo-5 (housing size 1, 2) or 1xThermo-6 (housing size 61) water up to 100 °C

- 1x Adapter for central coupling brass (O/ID T25651)
- 2x Nipple brass G $\frac{1}{2}$ -R $\frac{3}{4}$ (thread sealing)
- 2x Shut-off nipple with valve, G3/8-DN13
- 2x Quick-release shut-off coupling with hose nozzle, DN13
- 2x Nipple 1/4-3/8i-Msv
- 2x Hose nozzle brass DN13
- 2x Hose NBR DN13, Length 1,0 m
- 4x Hose clips

Treat-5, 1xThermo-5/6

O/ID T27015-1

Connection set Treat-5 to 2xThermo-5 (housing size 1, 2) or 2xThermo-6 (housing size 61) water up to 100 °C

- 1x Adapter for central coupling brass (O/ID T25651)
- 2x Nipple brass G $\frac{1}{2}$ -R $\frac{3}{4}$ (thread sealing)
- 2x Nipple brass G $\frac{1}{2}$ -R $\frac{3}{4}$ (thread sealing)
- 4x Hose nozzle brass DN13
- 2x Hose NBR DN13, Length 0,8 m
- 2x Hose NBR DN13, Length 0,6 m
- 8x Hose clips
- 1x Manifold set with quick-release shut-off couplings, DN13

Treat-5, 2xThermo-5/6

O/ID T27015-2

Connection set Treat-5 to 3xThermo-5 (housing size 1, 2) or 3xThermo-6 (housing size 61) water up to 100 °C

- 1x Adapter for central coupling brass (O/ID T25651)
- 2x Nipple brass G $\frac{1}{2}$ -R $\frac{3}{4}$ (thread sealing)
- 2x Nipple brass G $\frac{1}{2}$ -R $\frac{3}{4}$ (thread sealing)
- 4x Hose nozzle brass DN13
- 2x Hose NBR DN13, Length 0,8 m
- 2x Hose NBR DN13, Length 0,6 m
- 2x Hose NBR DN13, Length 0,7 m
- 12x Hose clips
- 2x Manifold set with quick-release shut-off couplings, DN13

Treat-5, 3xThermo-5/6

O/ID T27015-3

Connection set Treat-5 to 4xThermo-5 (housing size 1, 2) or 4xThermo-6 (housing size 61)		water up to 100 °C
1x	Adapter for central coupling brass (O/ID T25651)	
2x	Nipple brass G½-R¾ (thread sealing)	
2x	Nipple brass G½-R¾ (thread sealing)	
4x	Hose nozzle brass DN13	
2x	Hose NBR DN13, Length 0,8 m	
2x	Hose NBR DN13, Length 0,6 m	
4x	Hose NBR DN13, Length 0,7 m	
16x	Hose clips	
3x	Manifold set with quick-release shut-off couplings, DN13	
Treat-5, 4xThermo-5/6		O/ID T27015-4

Connection set Treat-5 to 2xThermo-5 (housing size 3)		water up to 100 °C
1x	Adapter for central coupling brass (O/ID T25651)	
2x	Nipple brass G¾ -R¾ (thread sealing)	
2x	Nipple brass G¾ -R½ (thread sealing)	
4x	Hose nozzle brass DN19	
2x	Hose NBR DN19, Length 0,9 m	
2x	Hose NBR DN19, Length 1,0 m	
8x	Hose clips	
1x	Manifold set with quick-release shut-off couplings, DN19	
Treat-5, 2xThermo-5		O/ID T28045-2

Ordering example: Connection set Treat-5/2xThermo-5, housing size 3 (O/ID T28045-2)

2 Electrical connections

2.1 Cable interface OPC UA (ZO)

Interface	Connection (1): - Machine (<i>Arburg, Engel, etc.</i>)	Connection (2): - Gate-6 - Thermo-6 - Thermo-5	Cable description	Length	O/ID
ZO	M12	RJ-45	RJ45/M12 d-coded	1,5 m	T28368-2
	M12	RJ-45	RJ45/M12 d-coded	2 m	T28368-5
	M12	RJ-45	RJ45/M12 d-coded	5 m	T28368-1
	M12	RJ-45	RJ45/M12 d-coded	6 m	T28368-3
	M12	RJ-45	RJ45/M12 d-coded	10 m	T28368-6
	M12	RJ-45	RJ45/M12 d-coded	12 m	T28368-4

Interface	Connection (1): - Machine (<i>Demag, Fanuc, KraussMaffei, etc.</i>) - Gate-6 - Thermo-6 - Thermo-5	Connection (2): - Gate-6 - Thermo-6 - Thermo-5	Cable description	Length	O/ID
ZO	RJ-45	RJ-45	none	1 m	T28976-102
	RJ-45	RJ-45	none	2 m	T28976-202
	RJ-45	RJ-45	none	3 m	T28976-302
	RJ-45	RJ-45	none	5 m	T28976-502
	RJ-45	RJ-45	none	10 m	T28976-103
	RJ-45	RJ-45	none	15 m	T28976-153
	RJ-45	RJ-45	none	20 m	T28976-203

2.2 Cable interface DIGITAL (ZD)

Machine manufacturer	Control system	Connection (1): - Machine	Connection (2): - Thermo-5 - Panel-5	Cable description	Length	O/ID
Arburg	Selogica, Selogica direct	Sub-D 9-p.	Interface DIGITAL (ZD) (Sub-D 25-p.)	Cable R1/20 mA	1 m	T20537-1
					2 m	T20537-3
					3 m	T20537-4
					4 m	T20537-5
					5 m	T20537
					6 m	T20537-9
					7 m	T20537-2
					7,5 m	T20537-7
					8 m	T20537-10
					10 m	T20537-6
15 m	T20537-11					
20 m	T20537-8					

Machine manufacturer	Control system	Connection (1): - Machine	Connection (2): - Thermo-5 - Panel-5	Cable description	Length	O/ID
Engel	Divers	Sub-D 25-p.+ Harting	Interface DIGITAL (ZD) (Sub-D 25-p.)	Cable R1/20 mA	2 m	T18703-8
					3 m	T18703-6
					5 m	T18703
					6 m	T18703-2
					7 m	T18703-4
					8 m	T18703-7
					10 m	T18703-1
					15 m	T18703-5
					20 m	T18703-3
				Sub-D 9-p.+ Harting	3 m	T22139-2
					4 m	T22139-6
					5 m	T22139-1
	10 m	T22139-3				
	15 m	T22139-4				
	Sub-D 25-p. + Harting	5 m		T16021		
		10 m		T16021-1		
	Flomo	Sub-D 9-p.		Cable R1/RS-485	3 m	T27302-2
					5 m	T27302-1
					8 m	T27302-3
Fanuc (SPI)	S 2000 iB	without plug	Cable R1/RS-485	5 m	T24398-1	
				7 m	T24398-3	
				10 m	T24398-2	
Ferromatik Milacron	Divers	Sub-D 25p.+ Harting	Cable R1/20 mA	5 m	T20434-1	
				Cable R1/RS-485	5 m	T22117-1
Haitian	Divers	Sub-D 9-p.	Cable R1/RS-485	5 m	T27984-1	
KraussMaffei	MC4/5/6	Sub-D 25-p.+ Harting	Cable R1/20 mA	2 m	T18703-8	
				3 m	T18703-6	
				5 m	T18703	
				6 m	T18703-2	
				7 m	T18703-4	
				8 m	T18703-7	
				10 m	T18703-1	
				15 m	T18703-5	
Negri Bossi	Divers	Sub-D 9-p.	Cable R1/RS-485	5 m	T22253-1	

Machine manufacturer	Control system	Connection (1): - Machine	Connection (2): - Thermo-5 - Panel-5	Cable description	Length	O/ID
Sumitomo (SHI) Demag	Ergotech ZE 556	Sub-D 25-p.+ Harting	Interface DIGITAL (ZD) (Sub-D 25-p.)	Cable R1/20 mA	2 m	T17042-5
					5 m	T17042
					7,5 m	T17042-3
					8 m	T17042-1
					10 m	T17042-4
					12 m	T17042-2
Wittmann Battenfeld	Unilog	Sub-D 9-p.		Cable R1/20 mA	5 m	T22428-1
					10 m	T22428-2
Zhafir	Divers	Sub-D 9-p.		Cable R1/RS-485	5 m	T27984-1

Ordering example: Cable R1/RS-485 (Zhafir);5 m (O/ID T27984-1)

Interface	Connection (1): - Thermo-5 - Panel-5	Connection (2): - Thermo-5 - Panel-5	Cable description	Length	O/ID
ZD	Interface DIGITAL (ZD) (Sub-D 25-p.)	Interface DIGITAL (ZD) (Sub-D 25-p.)	Cable R1-R2/RS-422	0,5 m	T15742-12
				0,6 m	T15742-9
				1 m	T15742
				1,5 m	T15742-1
				2 m	T15742-2
				2,5 m	T15742-6
				3 m	T15742-3
				3,5 m	T15742-13
				4 m	T15742-15
				5 m	T15742-4
				6 m	T15742-11
				7 m	T15742-10
				8 m	T15742-7
				10 m	T15742-5
				11,5 m	T15742-16
				13 m	T15742-17
15 m	T15742-8				
18 m	T15742-1				
20 m	T15742-14				

Ordering example: Cable R1-R2/RS-422; 0,6 m (O/ID T15742-9)

2.3 Cable interface CAN (ZC)						
Machine manufacturer	Control system	Connection (1): - Machine	Connection (2): - Thermo-5 - Panel-5	Cable description	Length	O/ID
Arburg	Divers (EM66)	Sub-D 9-p.	Interface CAN (ZC)	Cable CAN	0,6 m	T22571-5
					1 m	T22571-8
					1,8 m	T22571-2
					3 m	T22571-7
					5 m	T22571-1
					6 m	T22571-4
					7 m	T22571-6
					10 m	T22571-3
					20 m	T22571-10
					35 m	T22571-9
Netstal	DSP (EM 66)	Sub-D 9-p.		Cable CAN	0,6 m	T22571-5
					1 m	T22571-8
					1,8 m	T22571-2
					3 m	T22571-7
					5 m	T22571-1
					6 m	T22571-4
					7 m	T22571-6
					10 m	T22571-3
					20 m	T22571-10
					35 m	T22571-9
Sumitomo (SHI) Demag	Ergotech ZE 552	<i>CAN-Bus cable is already present on the machine. However, for the connection the adapter O/ID T22590 is required</i>		Cable adapter CAN	-	T22590
Wittmann Battenfeld	Divers	Sub-D 9-p.		Cable CAN	0,6 m	T22571-5
					1 m	T22571-8
					1,8 m	T22571-2
					3 m	T22571-7
					5 m	T22571-1
					6 m	T22571-4
					7 m	T22571-6
					10 m	T22571-3
					20 m	T22571-10
					35 m	T22571-9

Ordering example: Cable CAN (Netstal); 0,6 m (O/ID T22571-5)

Interface	Connection (1): - Thermo-5 - Panel-5	Connection (2): - Thermo-5 - Panel-5	Cable description	Length	O/ID
ZC	Interface CAN (Sub-D 9-p.)	Interface CAN (Sub-D 9-p.)	Cable CAN	0,6 m	T22571-5
				1 m	T22571-8
				1,8 m	T22571-2
				3 m	T22571-7
				5 m	T22571-1
				6 m	T22571-4
				7 m	T22571-6
				10 m	T22571-3
				20 m	T22571-10
				35 m	T22571-9

2.4 Cable interface **HB** (internal interface)

Interface	Connection (1): - Singular or modular unit Thermo-5 - Panel-5 - Vario-5	Connection (2): - Modular unit Thermo-5 - Vario-5	Cable description	Length	O/ID
HB	Interface HB (Sub-D 15-p.)	Interface HB (Sub-D 15-p.)	Cable HB	0,6 m	T24858-2
				1 m	T24858-1
				1,5 m	T24858-4
				2 m	T24858-5
				3 m	T24858-13
				5 m	T24858-3
				6 m	T24858-11
				7 m	T24858-7
				8 m	T24858-14
				10 m	T24858-9
				15 m	T24858-6
				20 m	T24858-8
				25 m	T24858-10
30 m	T24858-12				

Ordering example: Cable HB; 0,6 m (O/ID T24858-2)

Interface	Connection (1): - Singular or modular unit Thermo-5 - Panel-5 - Flow-5	Connection (2): - Flow-5	Cable description	Length	O/ID
HB	Interface HB (Sub-D 15-p.)	Interface HB (Sub-D 15-p.)	Cable HB	0,6 m	T25066-2
				1 m	T25066-1
				1,5 m	T25066-11
				2 m	T25066-10
				3 m	T25066-13
				4 m	T25066-5
				5 m	T25066-3
				6 m	T25066-7
				7 m	T25066-9
				7,5 m	T25066-8
				8 m	T25066-12
				10 m	T25066-4
				11 m	T25066-15
				15 m	T25066-6
20 m	T25066-14				

Ordering example: Cable HB, 2 m (O/ID T25066-10)

Notes: Flow meter Flow-5, autonom: Interface cable is not included.
Flow meter Flow-5, unit attached: Interface cable is included.

2.5 Cable interface HB/CAN (internal interface)					
Interface	Connection (1): - Singular or modular unit Thermo-5 - Panel-5 - Vario-5	Connection (2): - Singular unit Thermo-5 (in operation as a modular unit)	Cable description	Length	O/ID
HB	Interface HB (Sub-D 15-p.)	Interface CAN (Sub-D 9-p.)	Cable HB/CAN	0,6 m	T26825-2
				5 m	T26825-1
				10 m	T26825-4
				15 m	T26825-3
				20 m	T26825-5

Ordering example: Cable HB/CAN, 5 m (O/ID T26825-1)

2.6 Various cables					
Interface	Connection (1): - HB-Therm	Connection (2): - Machine	Cable description	Length	O/ID
ZA (Thermo-5)	Connection for alarm (Han 7D; 7-p.+ E)	without plug	Cable alarm contact	6 m	T24561-1
ZA (Flow-5)	Connection for alarm (Han 3A; 3-p. +E)		Cable alarm contact	5 m	T23377
ZB (Thermo-6, Thermo-5)	Connection for alarm and ext. control (Han 7D; 7-p.+ E)		Cable alarm contact and ext. control	6 m	T24562-1
		10 m		T24562-2	
		15 m		T24562-3	

2.7 Heat sensor			
	Heat sensor Pt 100, D=6 mm, 6 m (4 wire, without connector)	O/ID	T22060-1
	Adapter brass nickel-plated 12x25, G $\frac{1}{4}$	O/ID	T22061
	Adapter brass nickel-plated 12x25, M12x1	O/ID	T22062
	Connector male M12, 8-p. (additional equipment ZE) <i>(This plug is supplied with every Thermo-6 unit with the additional equipment ZE)</i>	O/ID	T26321
	Connector male 90°, PREH 5-p. (additional equipment ZE) <i>(This plug is supplied with every Thermo-5 unit with the additional equipment ZE)</i>	O/ID	T16042
	Cable adapter ZE (Plug M12 8-pin/socket 5-pin)	O/ID	T29279

Ordering example: Heat sensor Pt 100, D=6 mm, 6 (O/ID T22060-1)
 Adapter brass nickel-plated 12x25, G $\frac{1}{4}$ 12x25, G $\frac{1}{4}$ (O/ID T22061)
 Connector male M12, 8-p. (O/ID T26321)

Notes: Only use insulated heat sensors for Thermo-6 temperature control units.

2.8 Mains connector			
	Mains connector Type J 230 V, 10 A; LNPE (Swiss Type 12)	O/ID	T27551
	Mains connector Type F 230 V, 16 A; LNPE (Schuko)	O/ID	T27550
	Mains connector CEKON 230 V, 16 A; 3LPE	O/ID	T27211
	Mains connector CEKON 230 V, 16 A; 3LNPE	O/ID	T27210
	Mains connector CEKON 230 V, 32 A; 3LNPE	O/ID	T27252
	Mains connector CEKON 230 V, 32 A; 3LPE	O/ID	T21624
	Mains connector CEKON 400 V, 16 A; 3LPE	O/ID	T16622
	Mains connector CEKON 400 V, 16 A; 3LNPE	O/ID	T16429
	Mains connector CEKON 400 V, 32 A; 3LPE	O/ID	T16623

	Mains connector CEKON 400 V, 32 A; 3LNPE	O/ID	T16621
	Mains connector CEKON 400 V, 63 A; 3LNPE	O/ID	T23389
	Mains connector CEKON 500 V, 16 A; 3LPE	O/ID	T17796
	Mains connector J15 500 V, 15 A; 3LNPE	O/ID	T23396

Ordering example: Mains connector CEKON 400 V, 63 A; 3LNPE (O/ID T23389)

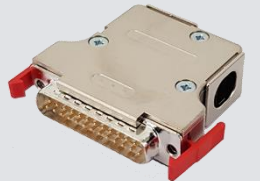
2.9 Connector (other)			
	Alarm and external control (Thermo-6: ZB ; Thermo-5: ZA, ZB) Connector female, Han 7D (7-p.+E) <i>(Crimping tool required for plug assembly)</i>	O/ID	T24623
	Interface DIGITAL (ZD) Connector male, Sub-D 25-p.	O/ID	T16048

2.10 Power distributor			
	Power distribution with 4 CEKON-sockets 16 A, 3LNPE with individual circuit breakers and central power cord with CEKON-plug 63 A, 3LNPE (HxWxD = 460x260x195 mm)	O/ID	T25621

3 Miscellaneous accessories

3.1 Screen protector Thermo-6

	Housing size 61, Material: PC	O/ID	T29560-1
	Housing size 61, Material: PET	O/ID	T29560-2
	Housing size 62, Material: PC	O/ID	T29560-3
	Housing size 62, Material: PET	O/ID	T29560-4

Note: The transparent flap protects against mechanical impacts and liquids. The operation of the touch screen remains possible.

3.2 Interface server Gate-6

	Power supply 85-265 VAC/24 VDC, 36 W; 1,5 m	O/ID	T28949
Extension cable for power supply	Cable with plug for EU; 1,8 m	O/ID	T28741-182
	Cable with plug for UK; 2 m	O/ID	T28740-202
	Cable with plug for US; 2 m	O/ID	T28739-202
Power supply Gate-6 via Thermo-6, interface HB	Cable HB/Gate-6 (Sub-D 15-p./Plug 3-p.; 5 m)	O/ID	T29390-502

*Ordering example: Power supply 85-265 VAC/24 VDC, 36 W; 1,5 m (O/ID T28949)
Cable with plug for UK; 2 m (O/ID T28740-202)*

Notes: For the power supply of the Gate-6 interface server, we recommend either the direct connection to the machine control (24 VDC) or the use of our power supply unit T28949. If no flow meter Flow-5 is connected to the temperature control unit, the Gate-6 can alternatively be supplied with power via the interface HB of the temperature control unit Thermo-6 using the cable T29390-502. For performance reasons, it is not possible to supply Gate-6 and Flow-5 with power via the interface HB at the same time.

3.3 Checking facility for temperature control units

	Type	HB-TP180-12	HB-TP200-12	HB-TP180-45
	heat transfer medium	Water	Oil	Water
	max. temperature in °C	180	200	180
	for connection main/return line	G¾	G¾	G1¼

Ordering example: *Checking facility HB-TP180-12, water, English*

Adapter for checking facility for Thermo-5, housing size 2B (HB-200/230Z2B) water up to 230 °C

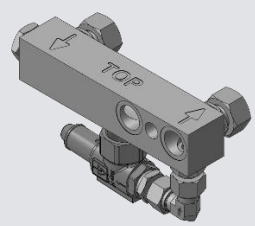

	1x Test adapter	O/ID	T28789
	2x Nipple stainless G3/4 - M30 with 24° sealing cone		
	1x Assembly paste (H1147)		
	1x Carrying case		

Ordering example: *Adapter for checking facility Thermo-5, housing size 2B (O/ID T28789)*

3.4 Keyboard-protection (Thermo-5, Treat-5, Clean-5, Panel-5)



	Keyboard-protection	O/ID	ZK

3.5 Flow meter Flow-5, unit attachment

Additional equipment		Type	HB-FM160	HB-FM180	HB-FM200
	Shut-off valves G½ (for all circuits)	O/ID	T25255 (ZH)	T25255-4 (ZH)	T25255-1 (ZH)
	Shut-off valve brass G½ (thread sealing; water up to 160 °C)	O/ID	T25918		
	Shut-off valve stainless G½ (with sealing lip; water up to 180 °C, oil up to 200 °C)	O/ID		T26006	T26006
Cable HB, 1 m		O/ID	T25066-1	T25066-1	T25066-1

Note: On flow meter Flow-5 (model: unit attachment), cable HB (O/ID T25066-1) for data interface is included.
 Cable HB → Other lengths see electrical connections (page 25)

3.6 Flow meter Flow-5, autonomic assembly

Additional equipment		Type	HB-FM160	HB-FM180
	Shut-off valves G½ (for all circuits)	O/ID	T26171-1 (ZH)	T26171-2 (ZH)
	Shut-off valve brass G½ (thread sealing; water up to 160 °C)	O/ID	T25918	
	Shut-off valve stainless G½ (with sealing lip; water up to 180 °C, oil up to 200 °C)	O/ID		T26006
	Parallel connection set G¾	O/ID	T26243-1	T26243-4
	Parallel connection set with shut-off valves G¾	O/ID	T26243-2	T26243-3
	Adjustable screw joint set G½ (per circuit; with sealing lip)	O/ID	T26173	T26173
Cable HB, 5 m		O/ID	T25066-3	T25066-3
Cable ZA, 5 m		O/ID	T23377	T23377

Note: On flow meter Flow-5 (model: autonomic assembly), cable HB for data interface is not included. Cable HB → Other lengths see electrical connections (page 25)

3.7 Control module Panel-5			
	Mains connector Type J (Swiss Type 12) 230 V, 10 A; LNPE	O/ID	T27551
	Mains connector Type F (Schuko) 230 V, 16 A; LNPE	O/ID	T27550
	Pivoting base for control module Panel-5	O/ID	T25620
	Mount for control module Panel-5	O/ID	T27726-1

Ordering example: *Mount for control module Panel-5 (O/D T27726-1)*

Note: *Cables for the data interfaces are not included in the scope of delivery of the Panel-5 control module.
Cables → Electrical connections (page 20)*

3.8 Carrier frame with central water supply

Note: Other versions available upon request.

Model designation Series 6

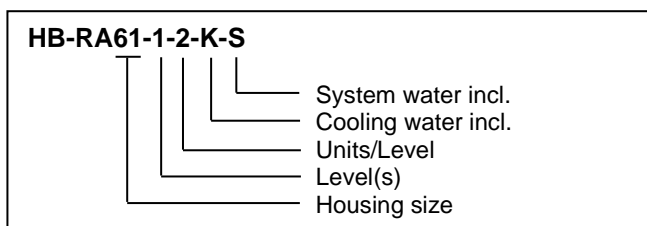

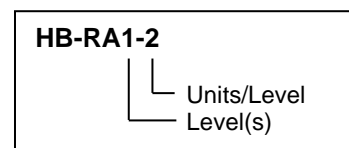

Model designation Series 5



Thermo-6, housing size 61							
Carrier frame with castors incl.: - cooling water distribution (K) Resistance: 10 bar, 100 °C	Type	K	S	High mm	Width mm	Depth mm	O/ID
	HB-RA61-1-3-K	G $\frac{3}{4}$	-	870	700	1070	T29319
	HB-RA61-1-4-K	G $\frac{3}{4}$	-	870	900	1070	T29612
	HB-RA61-2-2-K	G $\frac{3}{4}$	-	1550	580	1070	T29408
	HB-RA61-2-3-K	G $\frac{3}{4}$	-	1550	780	1070	T29323
	HB-RA61-2-5-K	G $\frac{3}{4}$	-	1625	1180	1090	T29385
Thermo-6, Baugröße 62							
Carrier frame with castors incl.: - cooling water distribution (K) Resistance: 10 bar, 100 °C	HB-RA62-2-2-K	G $\frac{3}{4}$	-	1830	800	1270	T29564
	HB-RA62-2-3-K	G $\frac{3}{4}$	-	1905	1110	1290	T29625

Ordering example: Carrier frame with central water supply HB-RA61-2-3-K (O/ID T29323)

Thermo-5, housing size 1							
Carrier frame with castors incl.: - cooling water distribution (K) Resistance: 10 bar, 100 °C	Type	K	S	High mm	Width mm	Depth mm	O/ID
	HB-RA1-2	G $\frac{3}{4}$	-	875	500	930	T25623
	HB-RA1-3	G $\frac{3}{4}$	-	875	690	930	T24923
	HB-RA1-4	G $\frac{3}{4}$	-	875	880	930	T25624
	HB-RA2-2	G $\frac{3}{4}$	-	1550	540	930	T25606
	HB-RA2-3	G $\frac{3}{4}$	-	1550	730	930	T25607
	HB-RA2-4	G $\frac{3}{4}$	-	1610	920	980	T25608
	HB-RA2-5	G $\frac{3}{4}$	-	1610	1110	980	T25609
	HB-RA2-6	G1	-	1610	1310	1060	T25610
	HB-RA2-7	G1	-	1680	1500	1060	T25611
	HB-RA2-8	G1	-	1680	1690	1060	T25612

Carrier frame with castors incl.: - cooling water distribution (K) - system water distribution (S) Resistance: 10 bar, 100 °C	HB-RA1-2	G $\frac{3}{4}$	G $\frac{1}{2}$	875	500	930	T25625
	HB-RA1-3	G $\frac{3}{4}$	G $\frac{1}{2}$	875	690	930	T25626
	HB-RA1-4	G $\frac{3}{4}$	G $\frac{1}{2}$	875	880	930	T25627
	HB-RA2-2	G $\frac{3}{4}$	G $\frac{1}{2}$	1550	540	930	T25613
	HB-RA2-3	G $\frac{3}{4}$	G $\frac{1}{2}$	1550	730	930	T25614
	HB-RA2-4	G $\frac{3}{4}$	G $\frac{1}{2}$	1610	920	980	T25615
	HB-RA2-5	G $\frac{3}{4}$	G $\frac{1}{2}$	1610	1110	980	T25616
	HB-RA2-6	G1	G $\frac{3}{4}$	1610	1310	1060	T25617
	HB-RA2-7	G1	G $\frac{3}{4}$	1680	1500	1060	T25618
	HB-RA2-8	G1	G $\frac{3}{4}$	1680	1690	1060	T25619
Thermo-5, Baugröße 2							
Carrier frame with castors incl.: - cooling water distribution (K) Resistance: 10 bar, 100 °C	HB-RA1-2	G $\frac{3}{4}$	-	1060	620	930	T26608
	HB-RA2-3	G $\frac{3}{4}$	-	1930	950	930	T25261
Other accessories for Series 5 carrier frame							
		Pivoting base for control module Panel-5					T25620

Note: Power distributor, see page 28

3.9 Switching unit Vario-5			
	Cable ext. control, 3m	O/ID	T26928-2
	Cable ext. control, 10 m <i>(included in standard equipment Vario-5)</i>	O/ID	T26928-1
	Proximity switch with magnetic base, 10 m	O/ID	T26821-10
	IR temperature sensor with magnetic base, 3 m	O/ID	T26819-1
	IR temperature sensor with magnetic base, 10 m	O/ID	T26819-10
	Emission level stickers 25 mm (7 pieces)	O/ID	T26843-1
	Mains connector Type J (Swiss Type 12) 230 V, 10 A; LNPE	O/ID	T27551
	Mains connector Type F (Schuko) 230 V, 16 A; LNPE	O/ID	T27550

Ordering example: IR temperature sensor with magnetic base, 3 m (O/ID T26819-1)

3.10 Water treatment unit Treat-5

Test kit Treat-5 für ST-DOS H-314	O/ID	T25984
Test kit Treat-5 für pH-Wert	O/ID	T26582
Conditioning agent ST-DOS H-390, 5 kg (approx. 250 L system water)	O/ID	T25907
Conditioning agent ST-DOS H-314, 5 kg (approx. 250 L system water)	O/ID	T25983

Note: Recommendation for pH tester: www.carlroth.com
 Recommended water treatment agents (D8087-EN): <http://hb.click/D8087-EN>



3.11 Cleaning unit Clean-5

Test kit Clean-5 for pH-Wert	O/ID	T26583
Cleaning agent BEIZER 640; 5 kg (ca. 100 L)	O/ID	T26569
Neutralising agent ST-DOS N-720; 5 kg (ca. 100 L)	O/ID	T26570
Conditioning and preserving agent ST-DOS H-314; 5 kg (ca. 250 L)	O/ID	T25983

Note: Recommendation for pH tester: www.carlroth.com
 Recommended agents for cleaning unit Clean-5 (D8111-EN): <http://hb.click/D8111-EN>



3.12 Shipping crate (wood)



(Example image)

Series 6	High mm	Width mm	Depth mm	O/ID
Shipping crate 1-2, Series 6 (Housing size 61, max. 2 units)	109	67	76	T28870-2
Shipping crate 1-3, Series 6 (Housing size 61, max. 3 units)	109	97	76	T28870-3
Shipping crate 1-4, Series 6 (Housing size 61, max. 4 units)	127	109	76	T28870-4
Shipping crate 2-2, Series 6 (Housing size 62, max. 2 units)	130	89	90	T29343-2
Shipping crate 2-3, Series 6 (Housing size 62, max. 3 units)	130	130	90	T29343-3
Series 5				
Shipping crate 1-2, Series 5 (Housing size 1, max. 2 units)	84	65	74	T27665-2
Shipping crate 1-3, Series 5 (Housing size 1, max. 3 units)	94	84	74	T27665-3
Shipping crate 1-4, Series 5 (Housing size 1, max. 4 units)	123	84	74	T27665-4
Shipping crate 2-2, Series 5 (Housing size 2, max. 2 units)	83	83	105	T27666-2
Shipping crate 2-3, Series 5 (Housing size 2, max. 3 units)	115	83	105	T27666-3
Shipping crate 2-4, Series 5 (Housing size 2, max. 4 units)	132	84	105	T27666-4
Shipping crate 3-1, Series 5 (Housing size 2B or 3, max. 1 unit)	117	50	125	T27667-1
Shipping crate 4-1, Series 5 (Housing size 4, max. 1 unit)	138	54	106	T28338-1

Ordering example: Shipping crate 1-2, Series 6 (O/ID T28870-2)

4 Manual

Note: [All instructions are available for free download in our knowledge base on our website. http://hb.click/6-Knowledge-EN](http://hb.click/6-Knowledge-EN)



4.1 Units (Operating manuals, process descriptions, instruction manuals)

Thermo-6	<i>Only available in Knowledge (see note)</i>			
Thermo-5	HB-100X1	O/ID	O8284-	
	HB-100X1L	O/ID	O8362-	
	HB-100XM1	O/ID	O8297-	
	HB-100XM1L	O/ID	O8363-	
	HB-100X2	O/ID	O8288-	
	HB-100X2L	O/ID	O8368-	
	HB-100XM2	O/ID	O8301-	
	HB-100XM2L	O/ID	O8370-	
	HB-100X3	O/ID	O8307-	
	HB-100XM3	O/ID	O8309-	
	HB-100X4	O/ID	O8391-	
	HB-100XM4	O/ID	O8392-	
	HB-100/140/160Z1	O/ID	O8285-	
	HB-100/140/160Z1L	O/ID	O8360-	
	HB-100/140/160ZM1	O/ID	O8298-	
	HB-100/140/160ZM1L	O/ID	O8361-	
	HB-100/140/160/180Z2	O/ID	O8289-	
	HB-100/140/160/180Z2L	O/ID	O8369-	
	HB-100/140/160/180ZM2	O/ID	O8302-	
	HB-100/140/160/180ZM2L	O/ID	O8371-	
	HB-100/140/160/180Z3	O/ID	O8308-	
	HB-100/140/160/180ZM3	O/ID	O8310-	
	HB-100/140/160Z4	O/ID	O8393-	
	HB-100/140/160ZM4	O/ID	O8394-	
	HB-200/230Z2B	O/ID	O8375-	
	HB-200/230ZM2B	O/ID	O8376-	
	HB-200T2	O/ID	O8300-	
	HB-200TM2	O/ID	O8303-	
	HB-250T3	O/ID	O8318-	
	HB-250TM3	O/ID	O8319-	
	Thermo-5 (Engel)	HB-100/140/160ZM1LE1	O/ID	O8367-
		HB-100/140/160ZM2LE2	O/ID	O8372-

Vario-5	HB-VS180	O/ID	O8340-	
	Process description	O/ID	O8352-	
	Autonomic operation	O/ID	O8386-	
	IR-Temperature sensor	O/ID	O8343-	
	Proximity switch	O/ID	O8387-	
Flow-5	HB-FM160/180/200	O/ID	O8295-	
Treat-5	HB-TR2	O/ID	O8304-	
	Test kit ST-DOS H-314	O/ID	O8336-	
	Test kit ST-DOS H-390	O/ID	O8351-	
Clean-5	HB-CL2	O/ID	O8305-	
	Instruction manual	O/ID	O8337-	
Panel-5	HB-FB51	O/ID	O8291-	
	HB-FB52E1 (Engel)	O/ID	O8366-	
Checking facility	HB-TP180/200	O/ID	O8354-	
Beer-5	HB-BR2	O/ID	O8350-	

Ordering example: *Instruction manual Thermo-5, HB-100/140/160Z1, English (O/ID O8285-EN)*

4.2 Other

Interface	Profibus-DP (ZP)	O/ID	O8241-	DE (German) EN (English)
	Profibus-DP Example	O/ID	O8293-	
	20 mA, RS-232, RS-422/485 (ZD)	O/ID	O8099-	
	MODBUS (RTU-Mode)	O/ID	O8242-	
VIP	Visualisation program	O/ID	O8975-	

Ordering example: *Manual MODBUS (RTU-Mode), English (O/ID O8242-EN)*